

TWR-K53N512 Tower Module

User's Manual

Rev. 0

Table of Contents

1	TWR-K53N512 and TWR-K53N512-KIT Overview	4
1.1	Contents	5
1.2	Features	5
1.3	Getting Started	6
1.4	Reference Documents	7
2	Hardware Description	7
2.1	K53N512 Microcontroller	8
2.2	Clocking	8
2.3	System Power	9
2.3.1	RTC VBAT	10
2.3.2	Measuring Current in Low Power Modes.....	10
2.4	Debug Interface	10
2.4.1	OSJTAG	10
2.4.2	Cortex Debug+ETM Connector.....	10
2.5	Infrared Port.....	11
2.6	Accelerometer	12
2.7	Potentiometer, Pushbuttons, LEDs.....	12
2.8	General Purpose Tower Plug-in (TWRPI) Socket.....	12
2.9	Touch Interface.....	13
2.10	Segment LCD	14
2.11	Ethernet	14
2.12	USB.....	14
2.13	Secure Digital Card Slot.....	15
2.14	External Bus Interface – FlexBus.....	15
2.15	Medical Connector	15
3	Jumper Table.....	16
4	Input/Output Connectors and Pin Usage Table.....	18
5	Tower Elevator Connections	20

List of Figures

Figure 1. Freescale Tower System Overview 4
 Figure 2. Callouts on front side of the TWR-K53N512..... 5
 Figure 3. Front side of TWR-K53N512 with TWRPI-SLCD attached 6
 Figure 4. Callouts on back side of the TWR-K53N512 6
 Figure 5. TWR-K53N512 Block Diagram..... 7
 Figure 6. Infrared Port Implementation 11

List of Tables

Table 1. Cortex Debug+ETM Connector Pinout 10
 Table 2. General Purpose TWRPI socket pinout 12
 Table 3. Touch TWRPI socket pinout 13
 Table 4. Ethernet operation jumper settings 14
 Table 5. Medical Connector 2x10 Pin Header Connections 16
 Table 6. TWR-K53N512 Jumper Table 16
 Table 7. I/O Connectors and Pin Usage Table..... 19
 Table 8. TWR-K53N512 Primary Connector Pinout 20

Revision History

Revision	Date	Changes
1.0	Aug 9, 2011	Initial Release for SCH-26994 REV C

1 TWR-K53N512 and TWR-K53N512-KIT Overview

The TWR-K53N512 is a Tower Controller Module compatible with the Freescale Tower System. It can function as a stand-alone, low-cost platform for the evaluation of the Kinetis K10, K20 and K53 family of microcontroller (MCU) devices. The TWR-K53N512 features the Kinetis K53 low-power microcontroller based on the ARM® Cortex™-M4 architecture with USB 2.0 full-speed OTG controller and 10/100 Mbps Ethernet MAC.

The TWR-K53N512 is available as a stand-alone product or as a kit (TWR-K53N512-KIT) with the Tower Elevator Modules (TWR-ELEV) and the Tower Serial Module (TWR-SER). The TWR-K53N512 can also be combined with other Freescale Tower peripheral modules to create development platforms for a wide variety of applications. 0 provides an overview of the Freescale Tower System.

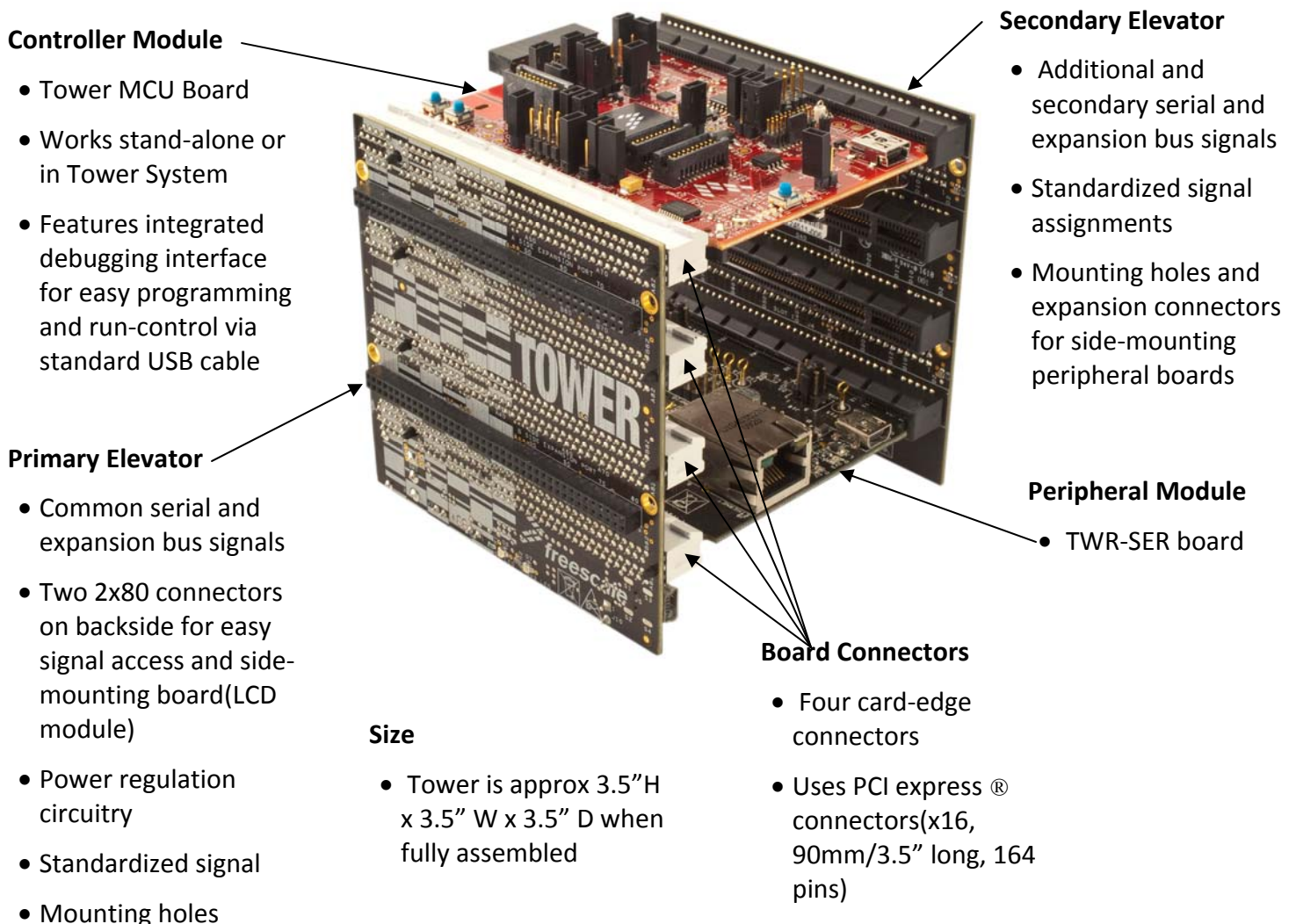

Figure 1. Freescale Tower System Overview

1.1 Contents

The TWR-K53N512 contents include:

- TWR-K53N512 board assembly
- 3ft USB cable
- Interactive DVD with software installers and documentation
- Quick Start Guide

The TWR-K53N512-KIT contains:

- TWR-K53N512 MCU module
- TWR-ELEV – Primary and Secondary Elevator Modules
- TWR-SER – Serial module including USB host/device/OTG, Ethernet, CAN, RS232 and RS485

1.2 Features

Figure 2 and **Figure 4** show the TWR-K53N512 with some of the key features called out. The following list summarizes the features of the TWR-K53N512 Tower MCU Module:

- PK53N512CMD100: K53N512 in a 144 MAPBGA with maximum 100MHz operation
- Touch Tower Plug-in Socket
- Medical Connector for MCU OPAMP, TRIAMP, DAC, ADC signals
- General purpose Tower Plug-in (TWRPI) socket
- On-board JTAG debug circuit (OSJTAG) with virtual serial port
- Three-axis accelerometer (MMA7660)
- Two (2) user-controllable LEDs
- Two (2) capacitive touch pads
- Two (2) user pushbutton switches
- Potentiometer
- Battery Holder for 20mm lithium battery (e.g. 2032, 2025)

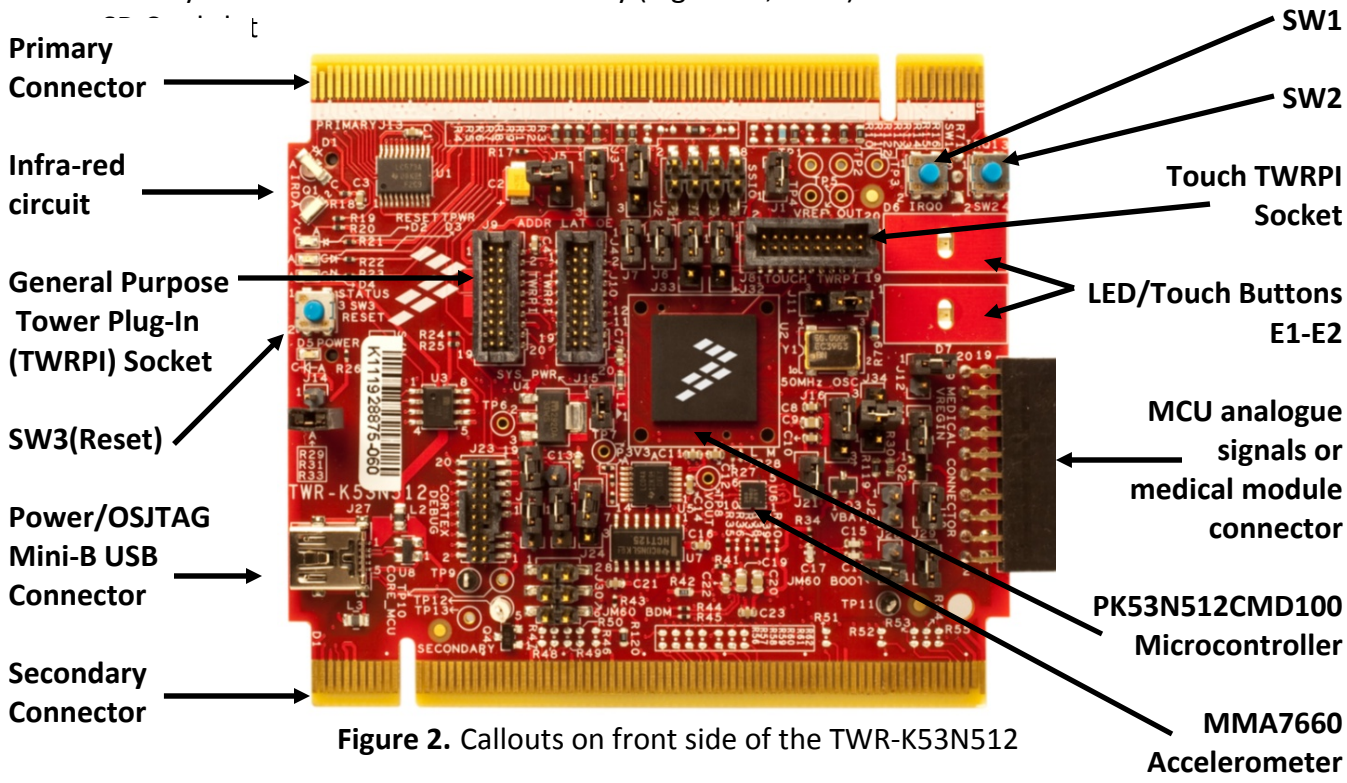

Figure 2. Callouts on front side of the TWR-K53N512

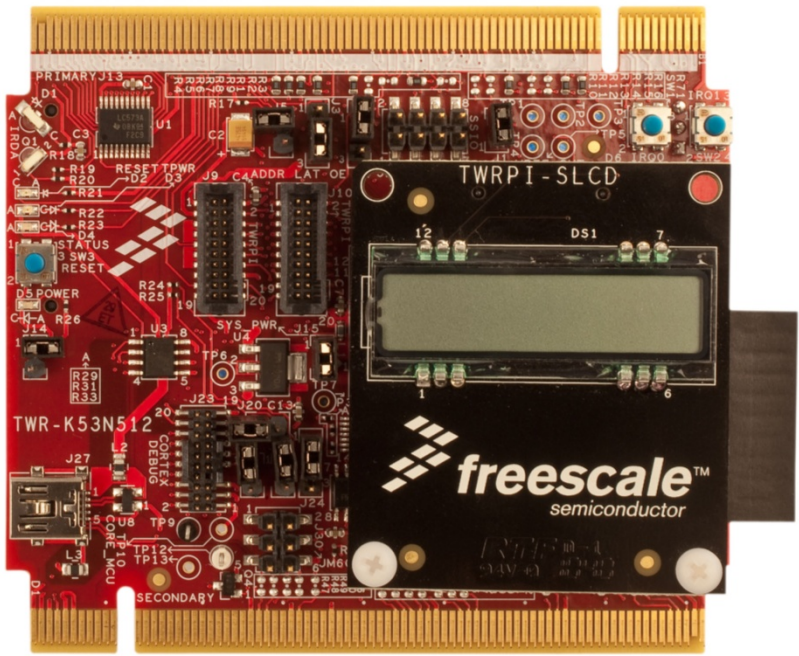

Figure 3. Front side of TWR-K53N512 with TWRPI-SLCD attached

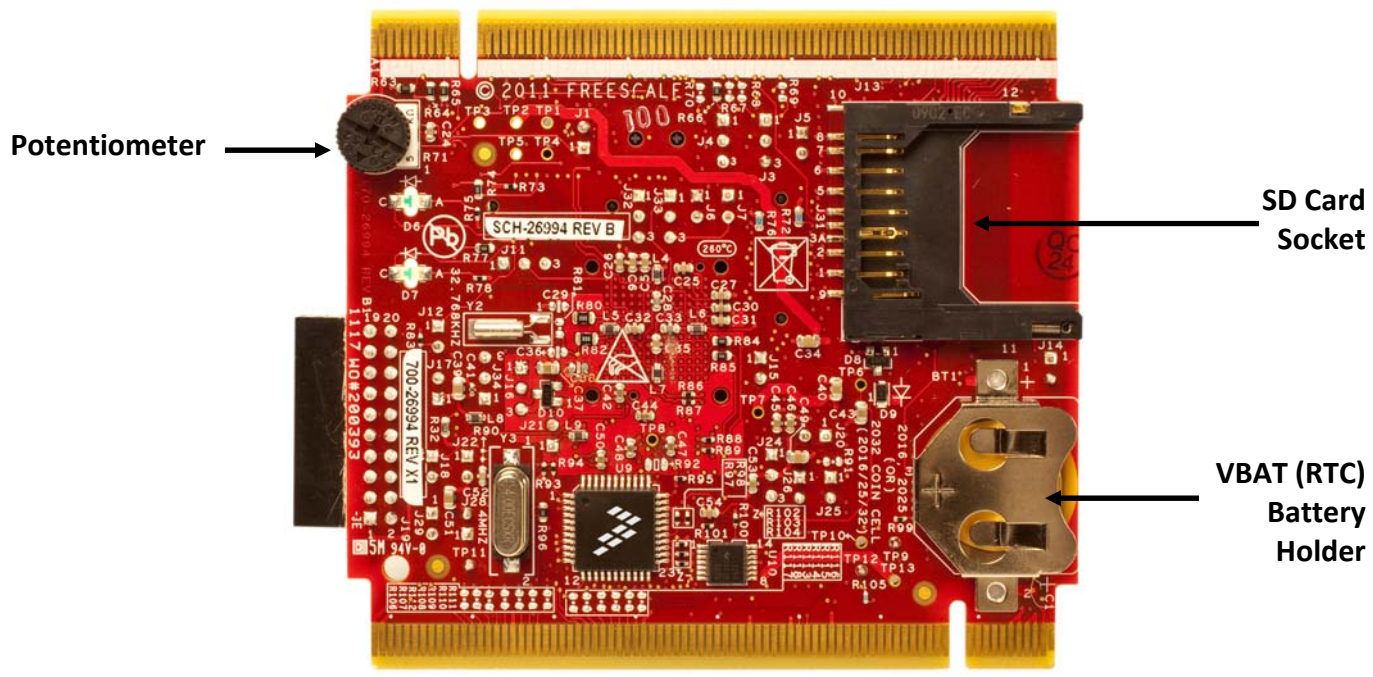

Figure 4. Callouts on back side of the TWR-K53N512

1.3 Getting Started

Follow the Quick Start Guide found printed in the TWR-K53N512 box or the interactive DVD for the list of recommended steps for getting started. There are also lab walk-through guides available on the tool support page for the TWR-K53N512: <http://www.freescale.com/TWR-K53N512>.

1.4 Reference Documents

The documents listed below should be referenced for more information on the Kinetis family, Tower System, and MCU Modules. These can be found in the documentation and downloads section of freescale.com/TWR-K53N512 or freescale.com/kinetis.

- *TWR-K53N512-QSG: Quick Start Guide*
- *TWR-K53N512-SCH: Schematics*
- *TWR-K53N512-PWA: Design Package*
- *TWRPI-SLCD-SCH: Schematics*
- *TWRPI-SLCD-PWA: Design Package*
- *K53 Family Product Brief*
- *K53 Family Reference Manual*
- *Kinetis Quick Reference User Guide (QRUG)*
- *Tower Configuration Tool*

2 Hardware Description

The TWR-K53N512 is a Tower Controller Module featuring the PK53N512CMD100—an ARM Cortex-M4 based microcontroller with segment LCD and USB 2.0 full-speed OTG controllers in a 144 MAPBGA package with a maximum core operating frequency of 100MHz. It is intended for use in the Freescale Tower System but can operate stand-alone. An on-board debug circuit, OSJTAG, provides a JTAG debug interface and a power supply input through a single USB mini-AB connector. **Figure 5** shows a block diagram of the TWR-K53N512. The following sections describe the hardware in more detail.

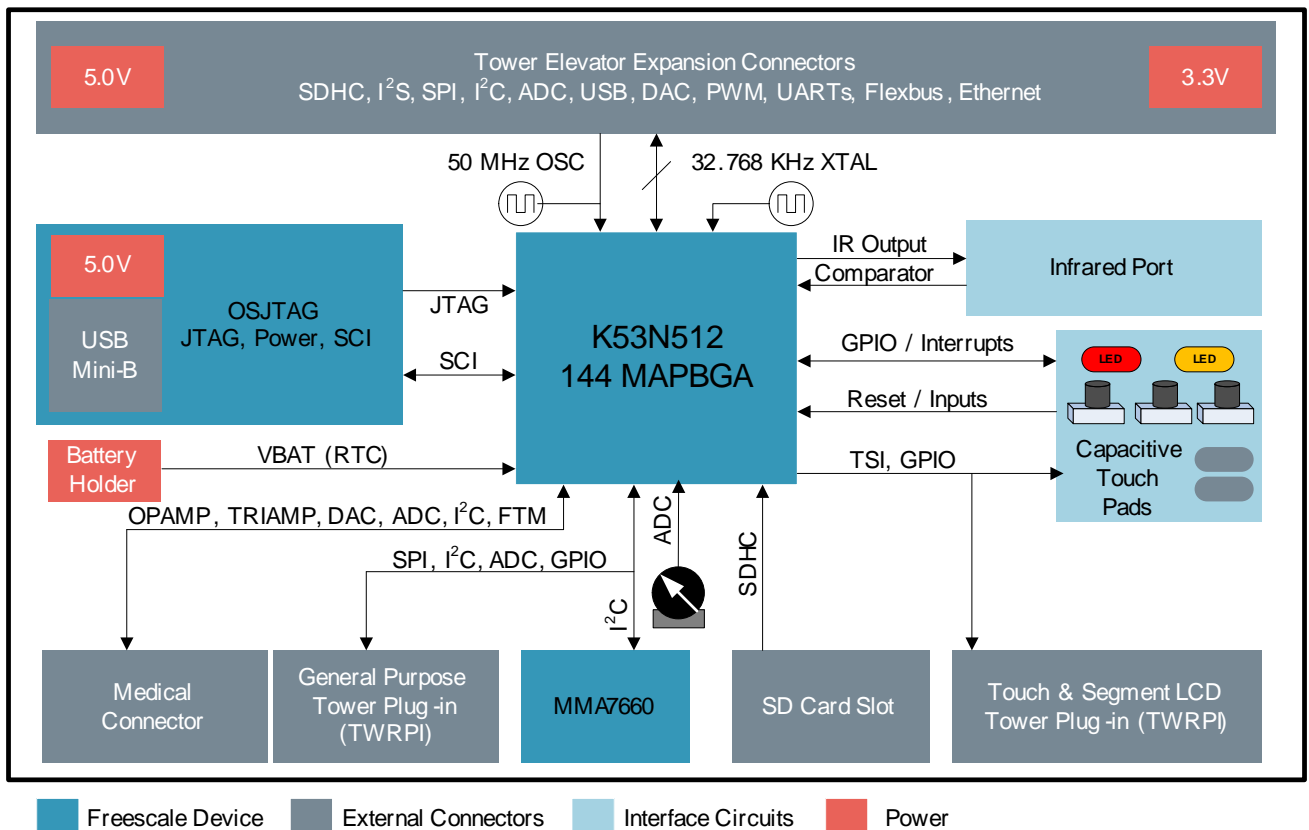

Figure 5. TWR-K53N512 Block Diagram

2.1 K53N512 Microcontroller

The TWR-K53N512 module features the PK53N512CMD100. The K53 microcontrollers are part of the K50 family from the Freescale's Kinetis portfolio built around an ARM Cortex-M4 core. Refer to the *K50 Family Product Brief* and the *K53 Family Reference Manual* for comprehensive information on the PK53N512CMD100 device. The key features are listed here:

- 32-bit ARM Cortex-M4 core with DSP instructions
- 100MHz maximum core operating frequency
- 144 MAPBGA, 13mm x 13mm, 1.0mm pitch package
- 1.71V – 3.6V operating voltage input range
- 128 Kbytes of static RAM (SRAM)
- 512 Kbytes of program only flash.
- K50 family also has devices that contain both program flash and FlexNVM. FlexNVM is non-volatile flash memory that can be used as program flash, data flash, backup EEPROM of variable endurance and size). Devices that have FlexNVM also have 4 Kbytes of FlexRAM (RAM memory that can be used as traditional RAM, as high-endurance EEPROM storage, or flash programming acceleration RAM)
- External bus interface
- Power management controller with 10 different power modes
- Multi-purpose clock generator with PLL and FLL operation modes
- Two (2) 16-bit SAR ADCs with extended internal and external input channels
- Two (2) 12-bit DACs. Each DAC has watermark interrupts and 16 word buffers.
- Three(3) High-speed analog comparator with 6-bit DAC
- Two (2) OPAMPs and two (2) TRIAMPs. Both OPAMP and TRIAMP can be used as general purpose operational amplifiers. OPAMP has extra features where it can be programmed as a buffer, inverting and non-inverting amplifier with various gains without external circuit
- Programmable voltage reference
- USB full-speed/low-speed OTG/Host/Device controller with device charge detect
- 10/100 Mbps Ethernet MAC
- SPI, I²C (w/ SMBUS support), UART (w/ ISO7816 and IrDA), I²S
- SD Host Controller (SDHC)
- GPIO with pin interrupt support, DMA request capability, digital glitch filtering
- Capacitive touch sensing inputs (TSI)
- Debug interfaces: JTAG, cJTAG, SWD
- Trace: TPIO, FPB, DWT, ITM, ETM, ETB

2.2 Clocking

The Kinetis MCUs start up from an internal digitally controlled oscillator (DCO). Software can enable one or two external oscillators if desired. The external oscillator for the Multipurpose Clock Generator (MCG) module can range from 32.768 KHz up to a 32 MHz crystal or ceramic resonator. The external oscillator for the Real Time Clock (RTC) module accepts a 32.768 kHz crystal.

The EXTAL pin of the main external oscillator can also be driven directly from an external clock source. The TWR-K53N512 features a 50 MHz on-board clock oscillator as seen in **sheet 3** of the schematics. However, when the K53 Ethernet MAC is operating in RMII mode, synchronization of the MCU input clock and the 50 MHz RMII transfer clock is important. In this mode, the MCU input clock must be kept

in phase with the 50 MHz clock supplied to the external PHY. Therefore, the TWR-K53N512 provides the option (see description for **J11** in **Table 6**) to select the clock input to the MCU from 1) the on-board 50MHz source or 2) an external clock from the CLKIN0 pin on the Primary Connector. When the K53 is operating in Ethernet RMII mode, the Tower peripheral module implementing the RMII PHY device should drive a 50 MHz clock on the CLKIN0 signal that is kept in phase with the clock supplied to the RMII PHY. Refer to section **2.101 “Segment LCD**

The segment LCD signals on the K53 devices are multiplexed with many other interface signals including several TSI signals that are accessible on the Touch TWRPI socket. Therefore, the Touch TWRPI socket on the TWR-K53N512 may also be used to evaluate the segment LCD controller of the K53 device. The TWRPI-SLCD daughter card included with the TWR-K53N512 plugs into the Touch TWRPI socket and provides a 28-segment LCD that can be driven directly by the K53 MCU. Refer to **Table 6 “I/O Connectors and Pin Usage Table”** for the segment LCD signals connection details. Additionally, many more segment LCD signals are routed to the Secondary Connector on the TWR-K53N512 and can be accessed from another Tower module or on the expansion connectors of the Secondary Elevator. These connections are currently disconnected, if you choose to do so please solder the zero ohms resistors for the signals. Please refer to **sheet 7** of schematics for detail. Ethernet” for more information.

2.3 System Power

In stand-alone operation, the main power source for the TWR-K53N512 module is derived from the 5.0V input from either the USB mini-B connector, **J27**, or the debug header, **J23**, when a shunt is placed on jumper **J12**. A low-dropout regulator provides a 3.3V supply from the 5.0V input voltage. Refer to sheet 5 of the TWR-K53N512 schematics for more details.

When installed into a Tower System, the TWR-K53N512 can be powered from either an on-board source or from another source in the assembled Tower System. If both the on-board and off-board sources are available, the TWR-K53N512 will default to the off-board source.

The 3.3V power supplied to the MCU is routed through a jumper, **J15**. The jumper shunt can be removed to allow for either 1) alternate MCU supply voltages to be injected or 2) the measurement of power consumed by the MCU.

The board system power (SYS_PWR) can be supplied from either the on board 3.3V regulator or from an external source via header **J22**. Header **J22 pin 2** is used to connect the external supply voltage and **J22 pin 1** is used to connect to the ground of the external supply source.

When **J24 pin 1-2** is shunt, board SYS_PWR is powered from on-board 3.3V regulator

When **J24 pin 2-3** is shunt, Board SYS_PWR is powered from off-board supply from **J22 pin 2**.

The schematic net name for the external power source is called P1V8. This doesn't mean it will output fixed at 1.8V because the supplied voltage depends on the external source. This board is only tested with 3.3V. Care should be taken not to connect to a voltage that is out of the components specification.

2.3.1 RTC VBAT

The Real Time Clock (RTC) module on the K53 has two modes of operation, system power-up and system power-down. During system power-down, the RTC is powered from the backup power supply, VBAT. The TWR-K53N512 provides a battery holder for a coin cell battery that can be used as the VBAT supply. The holder can accept common 20mm diameter 3V lithium coin cell batteries (e.g. 2032, 2025). Refer to the description **J12** in **Table 6** “TWR-K53N512 Jumper Table” for more information.

2.3.2 Measuring Current in Low Power Modes

When measuring MCU low power modes current, please select external clock source with **J11 pin 2-3** installed with Jumper. TWR-K53N512 will need to be assembled as tower system.

2.4 Debug Interface

There are two debug interface options provided: the on-board OSJTAG circuit and an external Cortex Debug+ETM connector.

2.4.1 OSJTAG

An on-board MC9S08JM60 based Open Source JTAG (OSJTAG) circuit provides a JTAG debug interface to the K53N512. A standard USB A male to Mini-B male cable (provided) can be used for debugging via the USB connector, **J27**. The OSJTAG interface also provides a USB to serial bridge. Drivers for the OSJTAG interface are provided in the *P&E Micro Kinetis Tower Toolkit* (available on the included DVD).

Note: **PTD7** connected to the OSJTAG USB-to-serial bridge is also connected to the infrared interface (IRDA). Refer to **Table 7** “I/O Connectors and Pin Usage Table” and **Table 6** “TWR-K53N512 Jumper Table” for more information.

2.4.2 Cortex Debug+ETM Connector

The Cortex Debug+ETM connector is a 20-pin (0.05") connector providing access to the SWD, SWV, JTAG, cJTAG, EzPort and ETM trace (4-bit) signals available on the K53 device. The pinout and K53 pin connections to the debug connector, **J23**, is shown in **Table 1**.

Table 1. Cortex Debug+ETM Connector Pinout

Pin	Function	TWR-K53N512 Connection
1	VTref	3.3V MCU supply (P3V3_MCU)
2	TMS / SWDIO	TSIO_CH4/PTA3/UART0_RTS/FTM0_CH0/JTAG_TMS/SWD_DIO
3	GND	GND
4	TCK / SWCLK	TSIO_CH1/PTA0/UART0_CTS/FTM0_CH5/JTAG_TCLK/SWD_CLK/EZP_CLK
5	GND	GND
6	TDO / SWO	TSIO_CH3/PTA2/UART0_TX/FTM0_CH7/JTAG_TDO/TRACE_SWO/EZP_DO
7	Key	—
8	TDI	TSIO_CH2/PTA1/UART0_RX/FTM0_CH6/JTAG_TDI/EZP_DI
9	GNDDetect	TSIO_CH5/PTA4/FTM0_CH1/NMI/EZP_CS
10	nRESET	RESET_b
11	Target Power	5V supply (via J16)
12	TRACECLK	PTA6/FTM0_CH3/FB_CLKOUT/TRACE_CLKOUT
13	Target Power	5V supply (via J16)

Pin	Function	TWR-K53N512 Connection
14	TRACEDATA[0]	PTA10/FTM2_CH0/MII0_RXD2/FB_AD15/FTM2_QD_PHA/TRACE_D0
15	GND	GND
16	TRACEDATA[1]	PTA9/FTM1_CH1/MII0_RXD3/FB_AD16/FTM1_QD_PHB/TRACE_D1
17	GND	GND
18	TRACEDATA[2]	ADC0_SE11/PTA8/FTM1_CH0/FB_AD17/FTM1_QD_PHA/TRACE_D2
19	GND	GND
20	TRACEDATA[3]	ADC0_SE10/PTA7/FTM0_CH4/FB_AD18/TRACE_D3

Note: Many of the trace signals connected to the debug connector are also connected elsewhere on the TWR-K53N512. Refer to **Table 7** "I/O Connectors and Pin Usage Table" and **Table 8** "TWR-K53N512 Primary Connector Pinout" for more information.

2.5 Infrared Port

An infrared transmit and receive interface is implemented as shown in **Figure 6** below. The CMT_IRO pin directly drives an infrared diode. The receiver uses an infrared phototransistor connected to an on-chip analog comparator. Internal to the K53 device, the output of the analog comparator can be routed to a UART module for easier processing of the incoming data stream.

Incoming signal can be filtered by a low-pass filter (0.1uF) when a jumper is installed on **J14**. Make sure your transmission rate is not too fast otherwise signal may be filtered. If this is the case, just remove the jumper from **J14**.

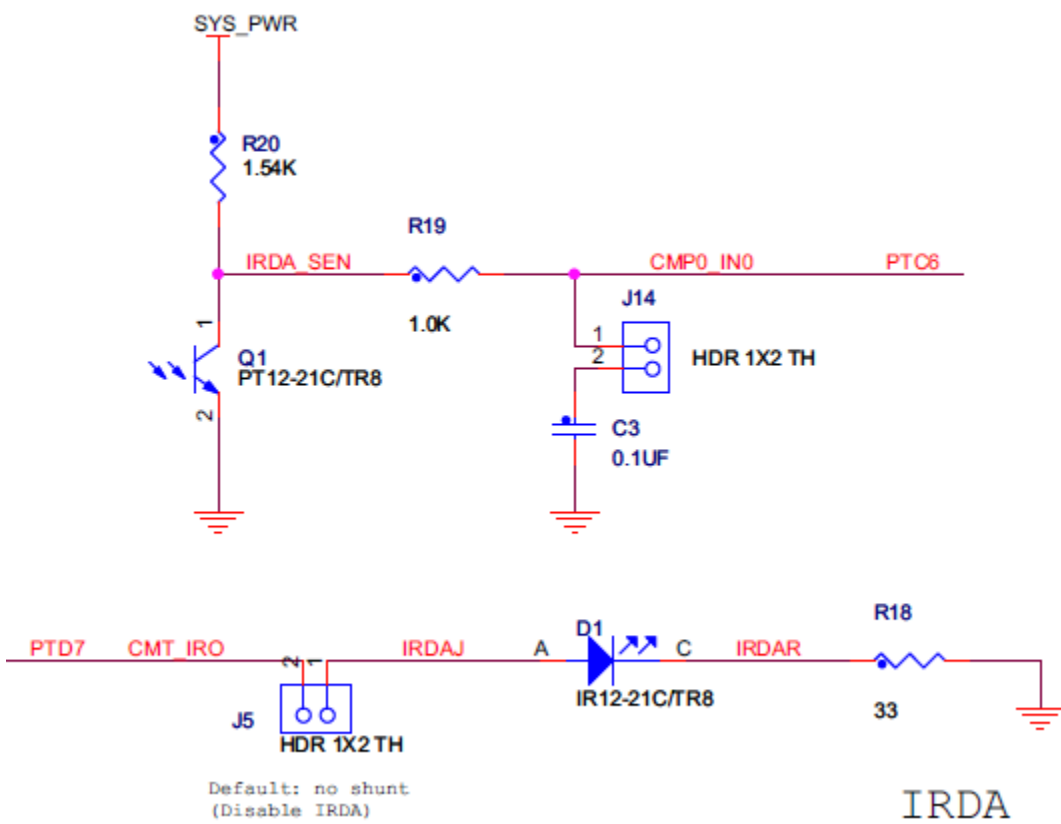

Figure 6. Infrared Port Implementation

2.6 Accelerometer

An MMA7660 digital accelerometer is connected to the K53 MCU through an I2C interface and a GPIO/IRQ signal. Refer to **Table 7** “I/O Connectors and Pin Usage Table” for connection details.

2.7 Potentiometer, Pushbuttons, LEDs

The TWR-K53N512 features two pushbutton switches connected to GPIO/interrupt signals, one pushbutton connected to the master reset signal, two capacitive touch pad electrodes, two user-controllable LEDs, and a potentiometer connected to an ADC input signal. Refer to **Table 7** “I/O Connectors and Pin Usage Table” for information about which port pins are connected to these features.

When Potentiometer is not monitored by MCU, **J1** jumper can be removed to allow the MCU ADC1_DM1 pin for other signal reading. Note that ADC1_DM1 also reads MEDICAL CONNECTOR signal.

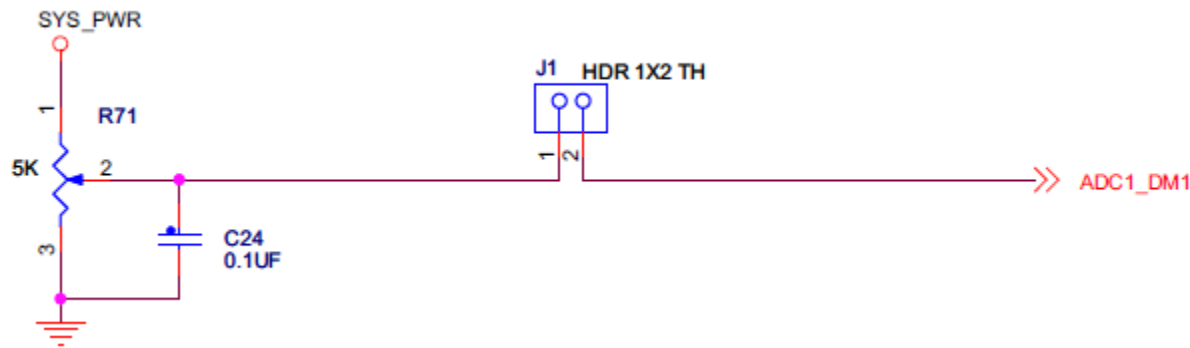

So you must remove **J1** jumper to avoid conflict when a module is connected to the medical

connector.

Figure 7. Potentiometer

2.8 General Purpose Tower Plug-in (TWRPI) Socket

The TWR-K53N512 features a socket that can accept a variety of different Tower Plug-in modules featuring sensors, RF transceivers, and more. The General Purpose TWRPI socket provides access to I2C, SPI, IRQs, GPIOs, timers, analog conversion signals, TWRPI ID signals, reset, and voltage supplies. The pinout for the TWRPI Socket is defined in **Table 2**.

Refer to **Table 7** “I/O Connectors and Pin Usage Table” for the specific K53 pin connections to the General Purpose TWRPI socket.

Table 2. General Purpose TWRPI socket pinout

Left-side 2x10 Connector		Right-side 2x10 Connector	
Pin	Description	Pin	Description
1	5V VCC	1	GND
2	3.3 V VCC	2	GND
3	GND	3	I2C: SCL

4	3.3V VDDA	4	I2C: SDA
5	VSS (Analog GND)	5	GND
6	VSS (Analog GND)	6	GND
7	VSS (Analog GND)	7	GND
8	ADC: Analog 0	8	GND
9	ADC: Analog 1	9	SPI: MISO
10	VSS (Analog GND)	10	SPI: MOSI
11	VSS (Analog GND)	11	SPI: SS
12	ADC: Analog 2	12	SPI: CLK
13	VSS (Analog GND)	13	GND
14	VSS (Analog GND)	14	GND
15	GND	15	GPIO: GPIO0/IRQ
16	GND	16	GPIO: GPIO1/IRQ
17	ADC: TWRPI ID 0	17	GPIO: GPIO2
18	ADC: TWRPI ID 1	18	GPIO: GPIO3
19	GND	19	GPIO: GPIO4/Timer
20	Reset	20	-

2.9 Touch Interface

The touch sensing input (TSI) module of the Kinetis MCUs provides capacitive touch sensing detection with high sensitivity and enhanced robustness. Each TSI pin implements the capacitive measurement of an electrode.

The TWR-K53N512 provides two methods for evaluating the TSI module. There are two individual electrodes on TWR-K53N512 that simulate pushbuttons. Additionally, twelve TSI signals are connected to a Touch Tower Plug-in (TWRPI) socket that can accept Touch TWRPI daughter cards that may feature keypads, rotary dials, sliders, etc.

The pinout for the Touch TWRPI socket is defined in **Table 3**. Refer to **Table 7** “I/O Connectors and Pin Usage Table” for the specific K53 pin connections to the Touch TWRPI socket.

Table 3. Touch TWRPI socket pinout

Pin	Description
1	5V VCC
2	3.3 V VCC
3	Electrode 0
4	3.3V VDDA
5	Electrode 1
6	VSS (Analog GND)
7	Electrode 2
8	Electrode 3
9	Electrode 4
10	Electrode 5
11	Electrode 6
12	Electrode 7
13	Electrode 8
14	Electrode 9
15	Electrode 10

Pin	Description
16	Electrode 11
17	ADC: TWRPI ID 0
18	ADC: TWRPI ID 1
19	GND
20	Reset

2.10 Segment LCD

The segment LCD signals on the K53 devices are multiplexed with many other interface signals including several TSI signals that are accessible on the Touch TWRPI socket. Therefore, the Touch TWRPI socket on the TWR-K53N512 may also be used to evaluate the segment LCD controller of the K53 device. The TWRPI-SLCD daughter card included with the TWR-K53N512 plugs into the Touch TWRPI socket and provides a 28-segment LCD that can be driven directly by the K53 MCU. Refer to **Table 6** “I/O Connectors and Pin Usage Table” for the segment LCD signals connection details. Additionally, many more segment LCD signals are routed to the Secondary Connector on the TWR-K53N512 and can be accessed from another Tower module or on the expansion connectors of the Secondary Elevator. These connections are currently disconnected, if you choose to do so please solder the zero ohms resistors for the signals. Please refer to **sheet 7** of schematics for detail.

2.11 Ethernet

The K53N512 features a 10/100 Mbps Ethernet MAC with MII and RMII interfaces. The TWR-K53N512 routes the RMII interface signals from the K53 MCU to the Primary Connector, allowing the connection to an external Ethernet PHY device on a Tower peripheral module.

When the K53 Ethernet MAC is operating in RMII mode, synchronization of the MCU clock and the 50 MHz RMII transfer clock is important. The MCU input clock must be kept in phase with the 50 MHz clock supplied to the external PHY. Therefore, the TWR-K53N512 provides the option (see description for **J11** in **Table 6**) to clock the MCU from an external clock from the CLKINO pin on the Primary Connector. The Tower peripheral module implementing the RMII PHY device should drive a 50 MHz clock on the CLKINO pin that is kept in phase with the clock supplied to the RMII PHY.

The TWR-SER module that comes as part of the TWR-K53N512-KIT provides a 10/100 Ethernet PHY that can operate in either MII or RMII mode. By default the PHY is boot strapped to operate in MII mode; therefore jumper configuration changes may be required. Table 4 shows the settings for proper interoperability between the Ethernet interface on the TWR-SER and the TWR-K53N512.

Table 4. Ethernet operation jumper settings

Tower Module	Jumper	Setting
TWR-K53N512	J11	2-3
TWR-SER	J2	3-4
TWR-SER	J3	2-3
TWR-SER	J12	9-10

2.12 USB

The K53N512 features a USB full-speed/low-speed OTG/Host/Device controller with built-in transceiver. The TWR-K53N512 routes the USB D+ and D- signals from the K53 MCU to the Primary

Connector, allowing the connection to external USB connectors or additional circuitry on a Tower peripheral module.

The TWR-SER module included as part of the TWR-K53N512-KIT provides a USB OTG/Host/Device interface with a mini-AB USB connector. There are many configuration options that can be selected to evaluate different USB modes of operation. By default, the TWR-SER is configured for USB Device operation. For more information on the configuration options, please refer to the User Manual for TWR-SER included with the TWR-SER kit or search for “User Manual for TWR-SER” from www.freescale.com

2.13 Secure Digital Card Slot

A Secure Digital (SD) card slot is available on the TWR-K53N512 connected to the SD Host Controller (SDHC) signals of the K53 MCU. This slot will accept SD memory cards as well as Secure Digital Input Output (SDIO) cards. Refer to **Table 7** “I/O Connectors and Pin Usage Table” or schematic for the SDHC signal connection details.

2.14 External Bus Interface – FlexBus

The K53 device features a multi-function external bus interface called the FlexBus interface controller capable of interfacing to slave-only devices. The FlexBus interface is not used directly on the TWR-K53N512. Instead, a subset of the FlexBus is connected to the Primary Connector so that the external bus can access devices on Tower peripheral modules.

The Primary Connector supports up to 20 address lines, 8 data lines, 2 chip-selects, read/write, and output enable signals. The SDHC signals of the K53 are multiplexed over the upper FlexBus address signals (FB_AD[27:24]), so a multiplexed mode of operation is used on the TWR-K53N512. An address latch is provided to de-multiplex the address and data signals prior to connecting them to the Primary Connector. Refer to sheet 8 of the TWR-K53N512 schematics for more details.

Note: The K53 Flexbus implementation provides an option for byte lane alignment. On the TWR-K53N512, FB_AD[7:0] are used for the data byte. Therefore, for proper operation software must set the CSCRx[BLS] bit to shift the data bus to the right byte lane. Refer to the FlexBus chapter in the K53 Family Reference Manual for more information.

2.15 Medical Connector

The TWR-K53N512 features a 2x10 expansion connector **J19** called the MEDICAL CONNECTOR in the schematic (also see **Table 5** below). This connector bridges the K53 MCU analog signals to external Freescale tower medical modules such as MED-EKG (Search MED-EKG from Freescale.com for detail)

The analog modules routed from K53N512 MCU to this connector are ADC0, ADC1 OPAMP0, OPAMP1, TRIAMP0, TRIAMP1, and DAC0.

K53N512 MCU GPIO **PTC14** is used to turn on or off the power supply to the medical connector module.

J19 Pin 4 can be selected via **J4** to use either I2C1_SCL signal or FTM2_CH1. FTM2_CH (Flex Timer) should be selected for the Pulse Oximeter module. See **Table 8** “TWR-K53N512 Primary Connector Pinout” for more information.

When the DSC MC56F8006 from the MED-EKG is enabled, K53N512 can choose to read the conditioned EKG results output from the DSC via I2C transmission (pin 3 and pin 4 via the medical connector). To enable

I2C communication, you must assemble the MEG-EKG as a Tower System (not just with the TWR-K53N512 stand alone). This is because the TWR-SER has the pulled up resistors circuit required for I2C transmission.

Table 5 highlights the functions that are used to implement the MED-EKG demonstration. For detail about the MED-EKG, please refer to the MED-EKG user manual, MED-EKG lab and schematic from Freescale.com/tower

Table 5. Medical Connector 2x10 Pin Header Connections

Tower Module	Jumper		Setting
Power (3.3V) (digitally turned ON/OFF by PTC14 GPIO)	1	2	Ground(GND)
I2C1_SDA	3	4	I2C1_SCL/FTM2_CH1
ADC0_DP0	5	6	ADC0_DM0
ADC1_DP0	7	8	DAC0_OUT
OP0_OUT	9	10	OP1_OUT
OP0_DM0	11	12	OP1_DM0
OP0_DP0	13	14	OP1_DP0
TRIO_DP	15	16	TRI1_DP
TRIO_DM	17	18	TRI1_DM
TRIO_OUT	19	20	TRI1_OUT

3 Jumper Table

There are several jumpers on the TWR-K53N512 that provide configuration selection and signal isolation. Refer to the following table for details. The default installed jumper settings are shown in bold with asterisks.

Table 6. TWR-K53N512 Jumper Table

Jumper	Option	Setting	Description
J1	ADC1_DM1 Input Selection	*ON*	ADC1_DM1 reads POTENTIOMETER
		OFF	ADC1_DM1 reads MEDICAL CONNECTOR
J3	FlexBus Address Latch Selection	*2-3*	Enable FlexBus address latch
		1-2	Disable FlexBus address latch
J4	Medical Connector J19 Pin4 Selection	*1-2*	Select I2C1_SCL connection to MEDICAL CONNECTOR
		2-3	Select FTM2_CH1 connection to MEDICAL CONNECTOR
J5	IR Transmitter Connection	*OFF*	Disconnect PTD7/CMT_IRO from IR transmitter circuit (IRDA)
		ON	Connect PTD7/CMT_IRO to IR transmitter circuit (IRDA)
J6	FlexBus or SSIO Selection	*ON*	Use PTE7 for Flex bus
		OFF	Use PTE7 for SSIO
J7	Ethernet/TOUCH PAD TWRPI Selection	ON	Use PTB0 for Ethernet
		OFF	Use PTB0 for TOUCH PAD TWRPI
J11	Clock Input Source Selection	*1-2*	Connect main EXTAL to on-board 50 MHz clock
		2-3	Connect EXTAL to the CLKIN0 signal on the elevator connector
J12	SD Card/TOUCH PAD TWRPI Selection	*OFF*	Use PTE2 for SD card reader (SD/MMC SKT)
		ON	Use PTE2 for TOUCH PAD TWRPI

J14	IR Transmitter Filter Selection	*OFF* ON	IR input to CMP0_IN0 is not low-pass filtered by a 0.1 uF cap IR input to CMP0_IN0 is low-pass filtered by a 0.1 uF cap
J15	MCU Power Connection	*ON* OFF	Connect on-board 3.3V supply to MCU Isolate MCU from power (connect an ammeter to measure current)
J16	VBAT Power Connection	*1-2* 2-3	Connect VBAT to on-board 3.3V supply Connect VBAT to the higher voltage between on-board 3.3V supply or coin-cell supply
J17	On-Board 50 MHz Power Connection	*ON* OFF	Connect on-board 3.3V supply to on-board 50 MHz OSC Disconnect on-board 3.3V supply to on-board 50 MHz OSC
J18	VREGION Power Connection	*ON* OFF	Connect USB0_VBUS from Elevator to VREGION Disconnect USB0_VBUS from Elevator to VREGION
J20	SD Card/GENERAL PURPOSE TWRPI Selection	*OFF* ON	Use PTE1 for SD card reader (SD/MMC SKT) Use PTE1 for GENERAL PURPOSE TWRPI

Jumper	Option	Setting	Description
J21	Accelerometer Power Connection	*ON* OFF	Connect accelerometer to on-board 3.3V supply Disconnect accelerometer from on-board 3.3V supply
J22	Off-Board Power input	Always OFF Always OFF	J22 pin 1 can be connected to an off-board external power source. This board is only tested with 3.3V. Care should be taken not to connect to a voltage that is out of the components specification J22 pin 2 can be connected to the ground of the off-board external power source
J24	Off or On Board Power Input Selection	*1-2* 2-3	Board SYS_PWR is powered from on-board 3.3V regulator Board SYS_PWR is powered from off-board supply from J22 pin 2
J25	JTAG Board Power Connection	*OFF* ON	Disconnect on-board 5V supply to JTAG port Connect on-board 5V supply to JTAG port (supports powering board from JTAG pod supporting 5V supply output)
J26	SD Card/GENERAL PURPOSE TWRPI Selection	*OFF* ON	Use PTE0 for SD card reader (SD/MMC SKT) Use PTE0 for GENERAL PURPOSE TWRPI
J28	OSJTAG Bootloader Selection	*OFF* ON	Debugger mode OSJTAG bootloader mode (OSJTAG firmware reprogramming)
J29	Ethernet/TOUCH PAD TWRPI Selection	*ON* OFF	Use PTB1 for Ethernet Use PTB1 for TOUCH PAD TWRPI
J32	TOUCH PAD/SLCD TWRPI Selection	*1-2* 2-3	PTB10_LCD_P10 pin is connected to J8 pin 3 for SLCD TWRPI PTB0_TSIO_CHO pin is connected to J8 pin 3 for TOUCH PAD TWRPI. Make sure J29 and J7 are off to avoid conflict with Ethernet
J33	TOUCH PAD/SLCD TWRPI Selection	*1-2* 2-3	PTB11_LCD_P11 pin is connected to J8 pin 5 for SLCD TWRPI PTB1_TSIO_CH6 pin is connected to J8 pin 5 for TOUCH PAD TWRPI. Make sure J29 and J7 are off to avoid conflict with Ethernet
J34	On-Board 50 MHz Enable Source	*OFF* 1-2 2-3	On-board 50 MHz osc is enabled if J17 jumper is on. No need to have any jumper on J34 On-board 50 MHz osc is enabled if J17 jumper is on On-board 50 MHz osc enable by GPIO PTA19 allowing MCU to turn off clock for lower power consumption

4 Input/Output Connectors and Pin Usage Table

The following table provides details on which K53N512 pins are using to communicate with the LEDs, switches, and other I/O interfaces onboard the TWR-K53N512.

Note: Some port pins are used in multiple interfaces on-board and many are potentially connected to off-board resources via the Primary and Secondary Connectors. Take care to avoid attempted simultaneous usage of mutually exclusive features.

Table 7. I/O Connectors and Pin Usage Table

Feature	Connection	Port Pin	Pin Function
OSJTAG USB-to-serial Bridge	OSJTAG Bridge RX Data	PTD6	UART0_RX
	OSJTAG Bridge TX Data	PTD7	UART0_TX
SD Card Slot	SD Clock	PTE2	SDHC0_DCLK
	SD Command	PTE3	SDHC0_CMD
	SD Data0	PTE1	SDHC0_D0
	SD Data1	PTE0	SDHC0_D1
	SD Data2	PTE5	SDHC0_D2
	SD Data3	PTE4	SDHC0_D3
	SD Card Detect	PTE28	PTE28
Infrared Port (IRDA)	IR Transmit	PTD7	CMT_IRO
	IR Receive	PTC6	CMPO_IN0
Pushbuttons	SW1 (IRQ0)	PTC5	PTC5
	SW2 (IRQ1)	PTC13	PTC13
	SW3 (RESET)	RESET_b	RESET_b
Touch Pads	E1 / Touch	PTB17	TSIO_CH10
	E2 / Touch	PTB18	TSIO_CH11
LEDs	E1 / Orange LED	PTC7	PTC7
	E2 / Yellow LED	PTC8	PTC8
Potentiometer	Potentiometer (R71)	—	ADC1_DM1
Accelerometer	I2C SDA	PTC11	I2C1_SDA
	I2C SCL	PTC10	I2C1_SCL
	IRQ	PTC12	PTC12
General Purpose TWRPI Socket	TWRPI AN0 (J9 Pin 8)	PTB6	PTB6
	TWRPI AN1 (J9 Pin 9)	PTB7	PTB7
	TWRPI AN2 (J9 Pin 12)	PTB5	PTB5
	TWRPI ID0 (J9 Pin 17)	PTE0	PTE0
	TWRPI ID1 (J9 Pin 18)	PTE1	PTE1
	TWRPI I2C SCL (J10 Pin 3)	PTC10	I2C0_SCL
	TWRPI I2C SDA (J10 Pin 4)	PTC11	I2C0_SDA
	TWRPI SPI MISO (J10 Pin 9)	PTB23	SPI2_SIN
	TWRPI SPI MOSI (J10 Pin 10)	PTB22	SPI2_SOUT
	TWRPI SPI SS (J10 Pin 11)	PTB20	SPI2_PCS0
	TWRPI SPI CLK (J10 Pin 12)	PTB21	SPI2_SCK
	TWRPI GPIO0 (J10 Pin 15)	PTC12	PTC12
	TWRPI GPIO1 (J10 Pin 16)	PTB9	PTB9
	TWRPI GPIO2 (J10 Pin 17)	PTB10	PTB10
	TWRPI GPIO3 (J10 Pin 18)	PTA19	PTA19
TWRPI GPIO4 (J10 Pin 19)	PTC13	PTC13	

Feature	Connection	Port Pin	Pin Function
Touch Pad / Segment LCD TWRPI Socket	Electrode 0 (J8 Pin 3)	PTB0/PTB10	TSIO_CH0/LCD_P10 (function selected by J32 jumper setting, see schematic)
	Electrode 1 (J8 Pin 5)	PTB1/PTB11	TSIO_CH6/LCD_P11(function selected by J33 jumper setting, see schematic)
	Electrode 2 (J8 Pin 7)	PTB2	TSIO_CH7
	Electrode 3 (J8 Pin 8)	PTB3	TSIO_CH8
	Electrode 4 (J8 Pin 9)	PTC0	TSIO_CH13
	Electrode 5 (J8 Pin 10)	PTC1	TSIO_CH14
	Electrode 6 (J8 Pin 11)	PTC2	TSIO_CH15
	Electrode 7 (J8 Pin 12)	PTA4	TSIO_CH5
	Electrode 8 (J8 Pin 13)	PTB16	TSIO_CH9
	Electrode 9 (J8 Pin 14)	PTB17	TSIO_CH10
	Electrode 10 (J8 Pin 15)	PTB18	TSIO_CH11
	Electrode 11 (J8 Pin 16)	PTB19	TSIO_CH12
	TWRPI ID0 (J8 Pin 17)	PTE2	PTE2
	TWRPI ID1 (J8 Pin 18)	—	ADC1_DM0

5 Tower Elevator Connections

The TWR-K53N512 features two expansion card-edge connectors that interface to the Primary and Secondary Elevator boards in a Tower system. The Primary Connector (comprised of sides A and B) is utilized by the TWR-K53N512 while the Secondary Connector (comprised of sides C and D) only makes connections to the GND pins. Table 8 provides the pinout for the Primary Connector.

Table 8. TWR-K53N512 Primary Connector Pinout

Pin #	Side B		Pin #	Side A	
	Name	Usage		Name	Usage
B1	5V	5.0V Power	A1	5V	5.0V Power
B2	GND	Ground	A2	GND	Ground
B3	3.3V	3.3V Power	A3	3.3V	3.3V Power
B4	ELE_PS_SENSE	Elevator Power Sense	A4	3.3V	3.3V Power
B5	GND	Ground	A5	GND	Ground
B6	GND	Ground	A6	GND	Ground
B7	SDHC_CLK / SPI1_CLK	PTE2	A7	SCL0	PTC10/ I2C1_SCL
B8	SDHC_D3 / SPI1_CS1_b		A8	SDA0	PTC11/ I2C1_SDA
B9	SDHC_D3 / SPI1_CS0_b	PTE4	A9	GPIO9 / CTS1	PTC19
B10	SDHC_CMD / SPI1_MOSI	PTE1	A10	GPIO8 / SDHC_D2	PTE5
B11	SDHC_D0 / SPI1_MISO	PTE3	A11	GPIO7 / SD_WP_DET	PTC9
B12	ETH_COL		A12	ETH_CRS	
B13	ETH_RXER	PTA5	A13	ETH_MDC	PTB1 connected via jumper J7
B14	ETH_TXCLK		A14	ETH_MDIO	PTB0 connected via jumper J29
B15	ETH_TXEN	PTA15	A15	ETH_RXCLK	
B16	ETH_TXER		A16	ETH_RXDV	PTA14
B17	ETH_TXD3		A17	ETH_RXD3	

Pin #	Side B		Pin #	Side A	
	Name	Usage		Name	Usage
B18	ETH_TXD2		A18	ETH_RXD2	
B19	ETH_TXD1	PTA17	A19	ETH_RXD1	PTA12
B20	ETH_TXD0	PTA16	A20	ETH_RXD0	PTA13
B21	GPIO1 / RTS1	PTC18	A21	SSI_MCLK	PTE6
B22	GPIO2 / SDHC_D1	PTE0	A22	SSI_BCLK	PTE12
B23	GPIO3	PTE28	A23	SSI_FS	PTE11
B24	CLKIN0	EXTAL/PTA18 connected via jumper J11	A24	SSI_RXD	PTE7
B25	CLKOUT1		A25	SSI_TXD	PTE10
B26	GND	Ground	A26	GND	Ground
B27	AN7	PTB10/ ACD0_SE14	A27	AN3	Solder connection for ADC0_DPO
B28	AN6	PTB11/ ACD0_SE15	A28	AN2	Solder connection ADC0_DM0
B29	AN5	PTB2/ ACD0_SE12	A29	AN1	Solder connection ADC1_DPO
B30	AN4	PTB3/ ACD0_SE13	A30	AN0	Solder connection ADC1_DM0
B31	GND	Ground	A31	GND	Ground
B32	DAC1	DAC1_OUT	A32	DACO	DACO_OUT
B33	TMR3	PTC5	A33	TMR1	PTA9
B34	TMR2	PTD6	A34	TMR0	PTA8
B35	GPIO4	PTB9	A35	GPIO6	PTB11
B36	3.3V	3.3V Power	A36	3.3V	3.3V Power
B37	PWM7	PTA2 needs soldering	A37	PWM3	PTC4
B38	PWM6	PTA1 needs soldering	A38	PWM2	PTC3
B39	PWM5	PTD5	A39	PWM1	PTC2
B40	PWM4	PTD4	A40	PWM0	PTC1
B41	CANRX0		A41	RXD0	PTC14
B42	CANTX0		A42	TXD0	PTC15
B43	1WIRE		A43	RXD1	PTC16
B44	SPI0_MISO	PTD3	A44	TXD1	PTC17
B45	SPI0_MOSI	PTD2	A45	VSS	VSSA
B46	SPI0_CS0_b	PTD0	A46	VDDA	VDDA
B47	SPI0_CS1_b	PTC3	A47	VREFA1	VREFH
B48	SPI0_CLK	PTD1	A48	VREFA2	VREFL
B49	GND	Ground	A49	GND	Ground
B50	SCL1	PTB2/I2C0_SCL	A50	GPIO14	
B51	SDA1	PTB3/I2C0_SDA	A51	GPIO15	
B52	GPIO5 / SD_CARD_DET	PTE28	A52	GPIO16	
B53	USB0_DP_PDOWN		A53	GPIO17	
B54	USB0_DM_PDOWN		A54	USB0_DM	USB0_DM
B55	IRQ_H	PTB5	A55	USB0_DP	USB0_DP
B56	IRQ_G	PTB5	A56	USB0_ID	
B57	IRQ_F	PTB6	A57	USB0_VBUS	VREGIN via jumper J18
B58	IRQ_E	PTB6	A58	TMR7	
B59	IRQ_D	PTB7	A59	TMR6	
B60	IRQ_C	PTB7	A60	TMR5	
B61	IRQ_B	PTB8	A61	TMR4	
B62	IRQ_A	PTB8	A62	RSTIN_b	RESET_b
B63	EBI_ALE / EBI_CS1_b	PTE6	A63	RSTOUT_b	PTC15
B64	EBI_CS0_b	PTE7	A64	CLKOUT0	PTA6
B65	GND	Ground	A65	GND	Ground

Pin #	Side B		Pin #	Side A	
	Name	Usage		Name	Usage
B66	EBI_AD15	PTA10	A66	EBI_AD14	PTA24
B67	EBI_AD16	PTA9	A67	EBI_AD13	PTA25
B68	EBI_AD17	PTA8	A68	EBI_AD12	PTA26
B69	EBI_AD18	PTA7	A69	EBI_AD11	PTA27
B70	EBI_AD19	PTA29	A70	EBI_AD10	PTA28
B71	EBI_R/W_b	PTD15	A71	EBI_AD9	PTD10
B72	EBI_OE_b	PTA11	A72	EBI_AD8	PTD11
B73	EBI_D7	PTD12	A73	EBI_AD7	LATCH_FB_A7
B74	EBI_D6	PTD13	A74	EBI_AD6	LATCH_FB_A6
B75	EBI_D5	PTD14	A75	EBI_AD5	LATCH_FB_A5
B76	EBI_D4	PTE8	A76	EBI_AD4	LATCH_FB_A4
B77	EBI_D3	PTE9	A77	EBI_AD3	LATCH_FB_A3
B78	EBI_D2	PTE10	A78	EBI_AD2	LATCH_FB_A2
B79	EBI_D1	PTE11	A79	EBI_AD1	LATCH_FB_A1
B80	EBI_D0	PTE12	A80	EBI_AD0	LATCH_FB_A0
B81	GND	Ground	A81	GND	Ground
B82	3.3V	3.3V Power	A82	3.3V	3.3V Power