

# RF Power Field Effect Transistors

## N-Channel Enhancement-Mode Lateral MOSFETs

Designed for W-CDMA and LTE base station applications with frequencies from 750 to 820 MHz. Can be used in Class AB and Class C for all typical cellular base station modulation formats.

- Typical Single-Carrier W-CDMA Performance:  $V_{DD} = 28$  Volts,  $I_{DQ} = 2000$  mA,  $P_{out} = 96$  Watts Avg., IQ Magnitude Clipping, Channel Bandwidth = 3.84 MHz, Input Signal PAR = 7.5 dB @ 0.01% Probability on CCDF.

Frequency	$G_{ps}$ (dB)	$\eta_D$ (%)	Output PAR (dB)	ACPR (dBc)
790 MHz	20.9	35.2	6.2	-38.1
805 MHz	21.0	35.5	6.2	-38.1
820 MHz	20.9	35.7	6.1	-38.2

- Capable of Handling 10:1 VSWR, @ 32 Vdc, 805 MHz, 500 Watts CW Output Power (3 dB Input Overdrive from Rated  $P_{out}$ ), Designed for Enhanced Ruggedness
- Typical  $P_{out}$  @ 1 dB Compression Point  $\approx 340$  Watts CW

### Features

- 100% PAR Tested for Guaranteed Output Power Capability
- Characterized with Series Equivalent Large-Signal Impedance Parameters and Common Source S-Parameters
- Internally Matched for Ease of Use
- Integrated ESD Protection
- Greater Negative Gate-Source Voltage Range for Improved Class C Operation
- Designed for Digital Predistortion Error Correction Systems
- Optimized for Doherty Applications
- In Tape and Reel. R6 Suffix = 150 Units, 56 mm Tape Width, 13-inch Reel.

**Table 1. Maximum Ratings**

Rating	Symbol	Value	Unit
Drain-Source Voltage	$V_{DSS}$	-0.5, +70	Vdc
Gate-Source Voltage	$V_{GS}$	-6.0, +10	Vdc
Operating Voltage	$V_{DD}$	32, +0	Vdc
Storage Temperature Range	$T_{stg}$	-65 to +150	$^{\circ}C$
Case Operating Temperature	$T_C$	150	$^{\circ}C$
Operating Junction Temperature (1,2)	$T_J$	225	$^{\circ}C$

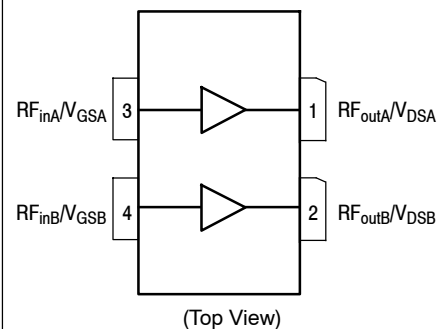
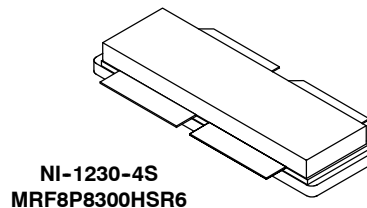
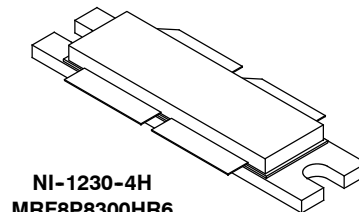
**Table 2. Thermal Characteristics**

Characteristic	Symbol	Value (2,3)	Unit
Thermal Resistance, Junction to Case Case Temperature 80 $^{\circ}C$ , 96 W CW, 28 Vdc, $I_{DQ} = 2000$ mA, 820 MHz Case Temperature 85 $^{\circ}C$ , 300 W CW, 28 Vdc, $I_{DQ} = 2000$ mA, 820 MHz	$R_{\theta JC}$	0.26 0.21	$^{\circ}C/W$

1. Continuous use at maximum temperature will affect MTTF.
2. MTTF calculator available at <http://www.freescale.com/rf>. Select Software & Tools/Development Tools/Calculators to access MTTF calculators by product.
3. Refer to AN1955, *Thermal Measurement Methodology of RF Power Amplifiers*. Go to <http://www.freescale.com/rf>. Select Documentation/Application Notes - AN1955.

**MRF8P8300HR6**  
**MRF8P8300HSR6**

**750-820 MHz, 96 W AVG., 28 V**  
**SINGLE W-CDMA**  
**LATERAL N-CHANNEL**  
**RF POWER MOSFETs**



**Figure 1. Pin Connections**

**Table 3. ESD Protection Characteristics**

Test Methodology	Class
Human Body Model (per JESD22-A114)	2
Machine Model (per EIA/JESD22-A115)	A
Charge Device Model (per JESD22-C101)	IV

**Table 4. Electrical Characteristics** ( $T_A = 25^\circ\text{C}$  unless otherwise noted)

Characteristic	Symbol	Min	Typ	Max	Unit
<b>Off Characteristics</b> <sup>(1)</sup>					
Zero Gate Voltage Drain Leakage Current ( $V_{DS} = 70\text{ Vdc}$ , $V_{GS} = 0\text{ Vdc}$ )	$I_{DSS}$	—	—	10	$\mu\text{Adc}$
Zero Gate Voltage Drain Leakage Current ( $V_{DS} = 28\text{ Vdc}$ , $V_{GS} = 0\text{ Vdc}$ )	$I_{DSS}$	—	—	1	$\mu\text{Adc}$
Gate-Source Leakage Current ( $V_{GS} = 5\text{ Vdc}$ , $V_{DS} = 0\text{ Vdc}$ )	$I_{GSS}$	—	—	1	$\mu\text{Adc}$

**On Characteristics**

Gate Threshold Voltage <sup>(1)</sup> ( $V_{DS} = 10\text{ Vdc}$ , $I_D = 400\ \mu\text{Adc}$ )	$V_{GS(th)}$	1.5	2.3	3.0	Vdc
Gate Quiescent Voltage ( $V_{DD} = 28\text{ Vdc}$ , $I_{DQ} = 2000\text{ mA}$ , Measured in Functional Test)	$V_{GS(Q)}$	2.3	3.1	3.8	Vdc
Drain-Source On-Voltage <sup>(1)</sup> ( $V_{GS} = 10\text{ Vdc}$ , $I_D = 3\text{ Adc}$ )	$V_{DS(on)}$	0.1	0.2	0.3	Vdc

**Functional Tests** <sup>(2)</sup> (In Freescale Test Fixture, 50 ohm system)  $V_{DD} = 28\text{ Vdc}$ ,  $I_{DQ} = 2000\text{ mA}$ ,  $P_{out} = 96\text{ W Avg.}$ ,  $f = 820\text{ MHz}$ , Single-Carrier W-CDMA, IQ Magnitude Clipping, Input Signal PAR = 7.5 dB @ 0.01% Probability on CCDF. ACPR measured in 3.84 MHz Channel Bandwidth @  $\pm 5\text{ MHz}$  Offset.

Power Gain	$G_{ps}$	20.0	20.9	23.5	dB
Drain Efficiency	$\eta_D$	34.5	35.7	—	%
Output Peak-to-Average Ratio @ 0.01% Probability on CCDF	PAR	5.9	6.1	—	dB
Adjacent Channel Power Ratio	ACPR	—	-38.2	-36.5	dBc
Input Return Loss	IRL	—	-12	-9	dB

**Typical Performance over Frequency** (In Freescale Test Fixture, 50 ohm system)  $V_{DD} = 28\text{ Vdc}$ ,  $I_{DQ} = 2000\text{ mA}$ ,  $P_{out} = 96\text{ W Avg.}$ , Single-Carrier W-CDMA, IQ Magnitude Clipping, Input Signal PAR = 7.5 dB @ 0.01% Probability on CCDF. ACPR measured in 3.84 MHz Channel Bandwidth @  $\pm 5\text{ MHz}$  Offset.

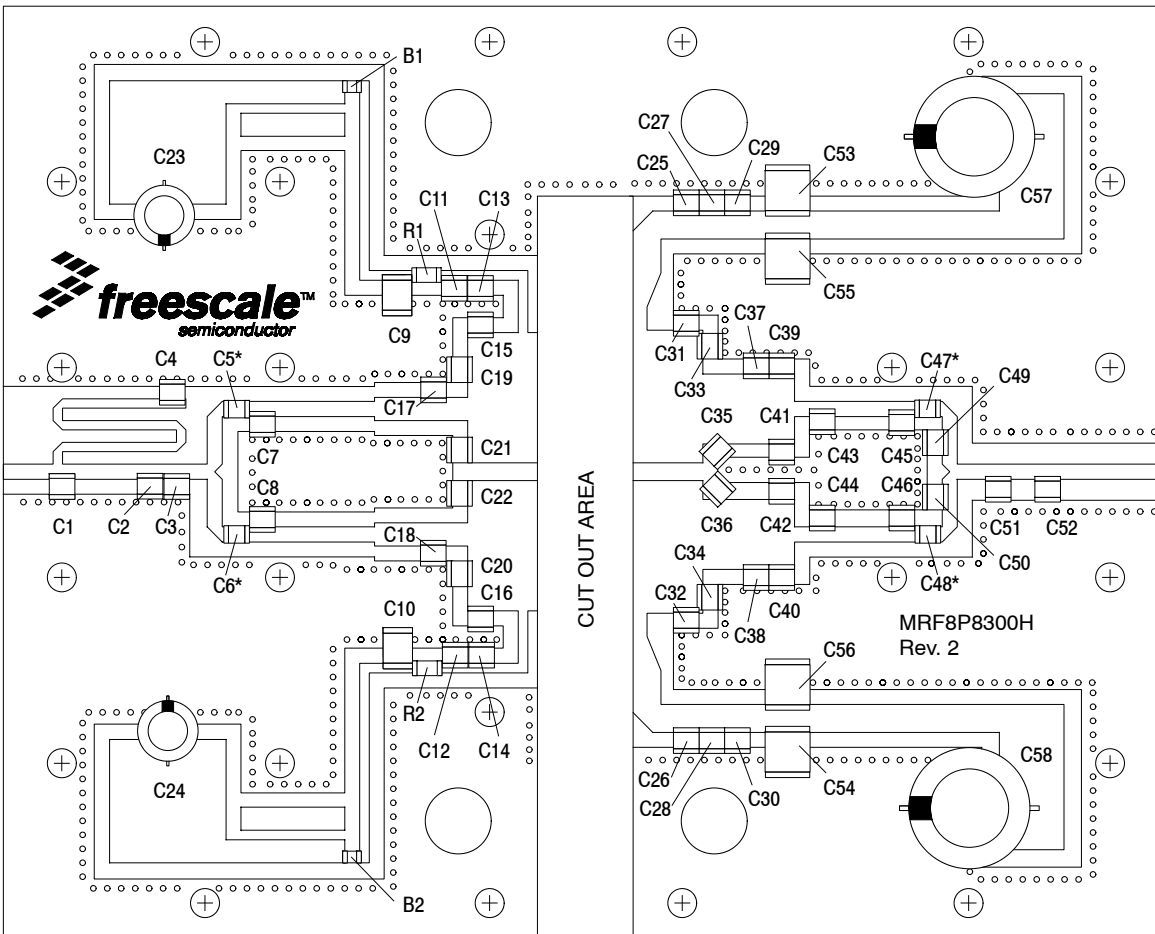
Frequency	$G_{ps}$ (dB)	$\eta_D$ (%)	Output PAR (dB)	ACPR (dBc)	IRL (dB)
790 MHz	20.9	35.2	6.2	-38.1	-11
805 MHz	21.0	35.5	6.2	-38.1	-12
820 MHz	20.9	35.7	6.1	-38.2	-12

1. Each side of device measured separately.
2. Part internally matched both on input and output.

(continued)

**Table 4. Electrical Characteristics** ( $T_A = 25^\circ\text{C}$  unless otherwise noted) (continued)

Characteristic	Symbol	Min	Typ	Max	Unit
<b>Typical Performances</b> (In Freescale Test Fixture, 50 ohm system) $V_{DD} = 28\text{ Vdc}$ , $I_{DQ} = 2000\text{ mA}$ , 790–820 MHz Bandwidth					
$P_{out}$ @ 1 dB Compression Point, CW	$P_{1dB}$	—	340	—	W
IMD Symmetry @ 290 W PEP, $P_{out}$ where IMD Third Order Intermodulation $\cong 30\text{ dBc}$ (Delta IMD Third Order Intermodulation between Upper and Lower Sidebands $> 2\text{ dB}$ )	$IMD_{sym}$	—	35	—	MHz
VBW Resonance Point (IMD Third Order Intermodulation Inflection Point)	$VBW_{res}$	—	35	—	MHz
Gain Flatness in 30 MHz Bandwidth @ $P_{out} = 96\text{ W Avg.}$	$G_F$	—	0.5	—	dB
Gain Variation over Temperature ( $-30^\circ\text{C}$ to $+85^\circ\text{C}$ )	$\Delta G$	—	0.0185	—	dB/ $^\circ\text{C}$
Output Power Variation over Temperature ( $-30^\circ\text{C}$ to $+85^\circ\text{C}$ )	$\Delta P_{1dB}$	—	0.0076	—	dB/ $^\circ\text{C}$



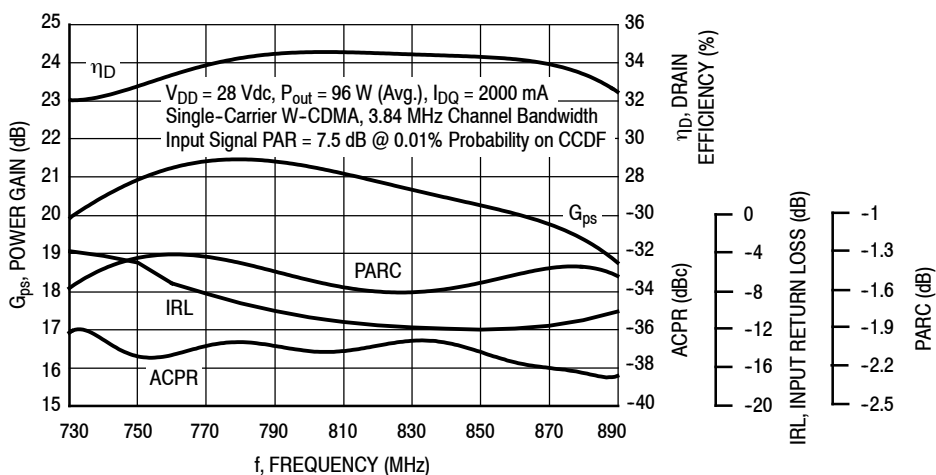
\*C5, C6, C47, and C48 are mounted vertically.

**Figure 2. MRF8P8300HR6(HSR6) Test Circuit Component Layout**

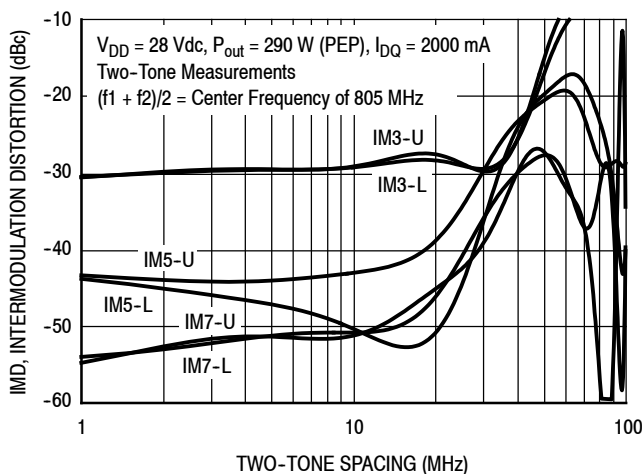
**Table 5. MRF8P8300HR6(HSR6) Test Circuit Component Designations and Values**

Part	Description	Part Number	Manufacturer
B1, B2	Short Ferrite Beads	MPZ2012S300AT000	TDK
C1, C2, C39, C40, C41, C42	2.1 pF Chip Capacitors	ATC100B2R1BT500XT	ATC
C3, C49, C50	1.0 pF Chip Capacitors	ATC100B1R0BT500XT	ATC
C4	120 pF Chip Capacitor	ATC100B121JT500XT	ATC
C5, C6, C11, C12, C47, C48	39 pF Chip Capacitors	ATC100B390JT500XT	ATC
C7, C8, C45, C46	1.1 pF Chip Capacitors	ATC100B1R1BT500XT	ATC
C9, C10	4.7 $\mu$ F, 50 V Chip Capacitors	C4532X5R1H475KT	TDK
C13, C14, C19, C20, C25, C26	10 pF Chip Capacitors	ATC100B100JT500XT	ATC
C15, C16, C35, C36	4.7 pF Chip Capacitors	ATC100B4R7CT500XT	ATC
C17, C18	4.3 pF Chip Capacitors	ATC100B4R3CT500XT	ATC
C21, C22	8.2 pF Chip Capacitors	ATC100B8R2CT500XT	ATC
C23, C24	22 $\mu$ F Electrolytic Capacitors	UUD1V220MCL1GS	Nichicon
C27, C28	20 pF Chip Capacitors	ATC100B200JT500XT	ATC
C29, C30	30 pF Chip Capacitors	ATC100B300JT500XT	ATC
C31, C32	13 pF Chip Capacitors	ATC100B130JT500XT	ATC
C33, C34	7.5 pF Chip Capacitors	ATC100B7R5CT500XT	ATC
C37, C38	1.5 pF Chip Capacitors	ATC100B1R5BT500XT	ATC
C43, C44	0.8 pF Chip Capacitors	ATC100B0R8BT500XT	ATC
C51, C52	2.0 pF Chip Capacitors	ATC100B2R0BT500XT	ATC
C53, C54, C55, C56	22 $\mu$ F, 50 V Chip Capacitors	C5750JF1H226ZT	TDK
C57, C58	470 $\mu$ F, 63 V Electrolytic Capacitors	MCGPR63V477M13X26-RH	Multicomp
R1, R2	3 $\Omega$ Chip Resistors	CRCW12063R00FNEA	Vishay
PCB	0.030", $\epsilon_r = 3.5$	RF35A2	Taconic

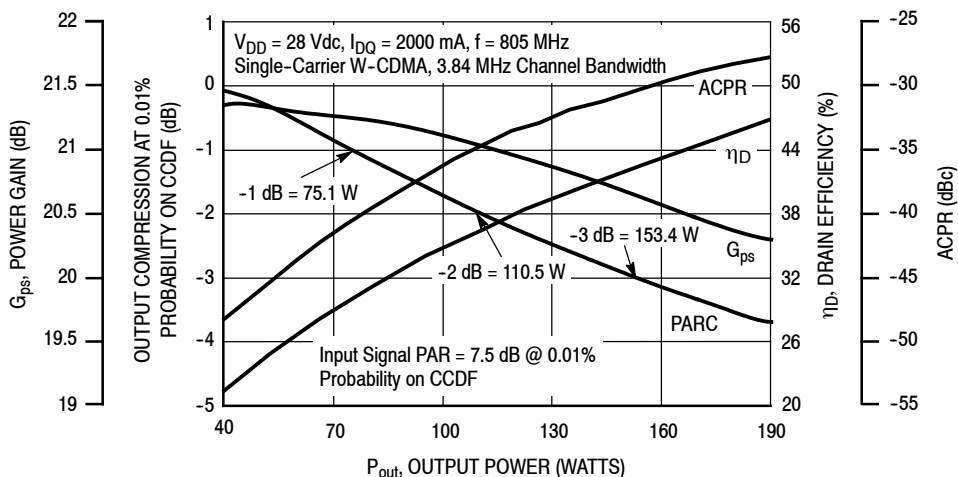
### TYPICAL CHARACTERISTICS



**Figure 3. Output Peak-to-Average Ratio Compression (PARC) Broadband Performance @  $P_{out} = 96$  Watts Avg.**

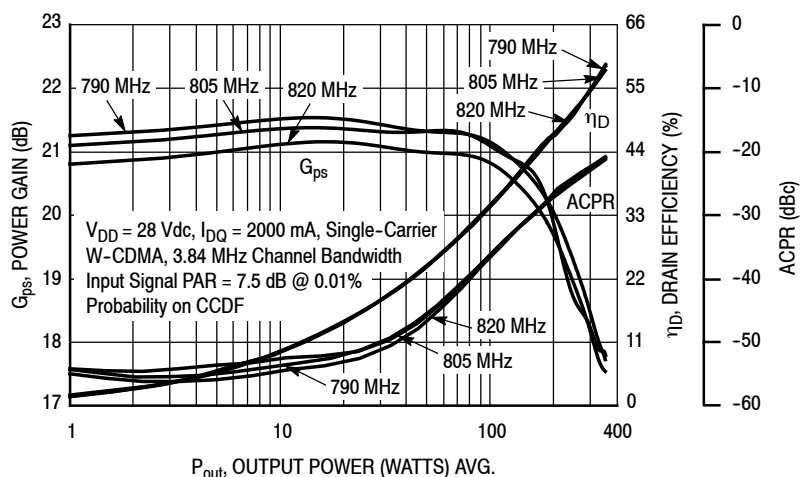


**Figure 4. Intermodulation Distortion Products versus Two-Tone Spacing**

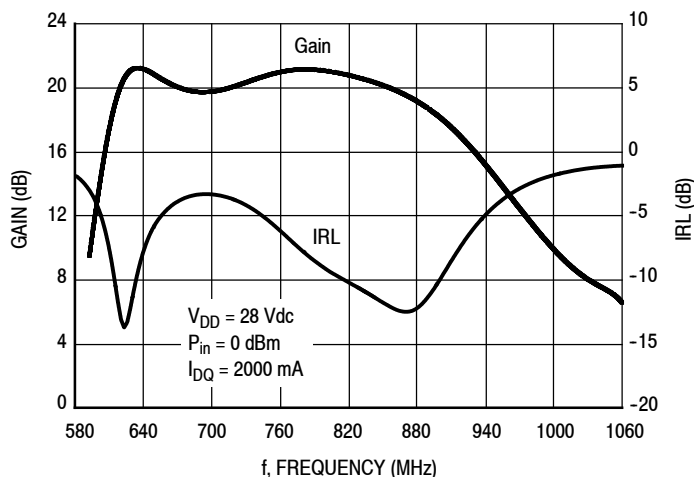


**Figure 5. Output Peak-to-Average Ratio Compression (PARC) versus Output Power**

### TYPICAL CHARACTERISTICS

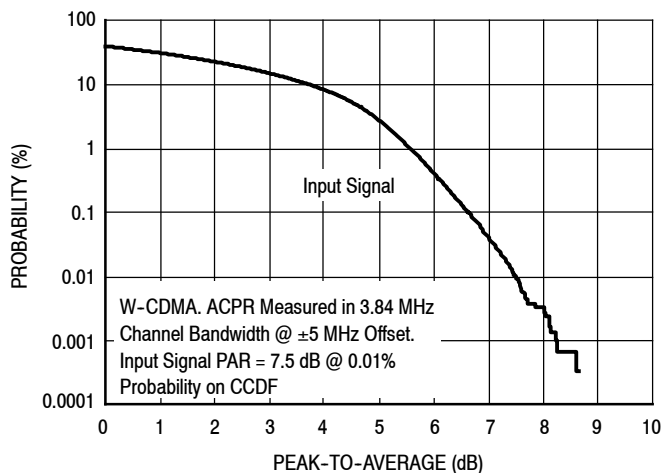


**Figure 6. Single-Carrier W-CDMA Power Gain, Drain Efficiency and ACPR versus Output Power**

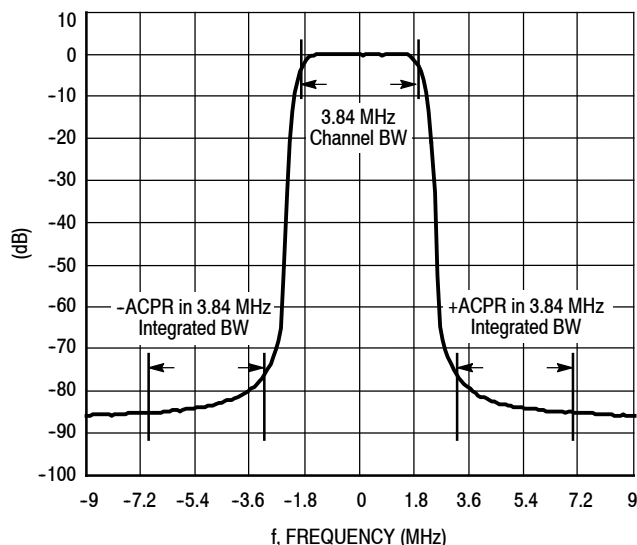


**Figure 7. Broadband Frequency Response**

### W-CDMA TEST SIGNAL



**Figure 8. CCDF W-CDMA IQ Magnitude Clipping, Single-Carrier Test Signal**



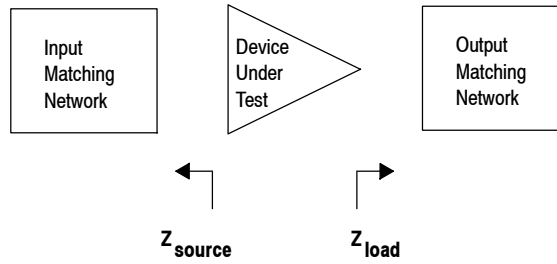
**Figure 9. Single-Carrier W-CDMA Spectrum**

$V_{DD} = 28 \text{ Vdc}$ ,  $I_{DQ} = 2000 \text{ mA}$ ,  $P_{out} = 96 \text{ W Avg.}$

f MHz	$Z_{source}$ $\Omega$	$Z_{load}$ $\Omega$
730	$1.07 - j1.15$	$0.86 - j0.18$
750	$1.06 - j0.97$	$0.90 + j0.04$
770	$1.11 - j0.78$	$1.07 + j0.46$
790	$1.05 - j0.62$	$1.28 - j0.67$
810	$1.11 - j0.45$	$0.88 - j0.12$
830	$1.19 - j0.26$	$0.87 + j0.04$
850	$1.95 + j0.48$	$0.82 + j0.05$
870	$1.35 - j1.66$	$0.71 + j0.12$
890	$0.95 - j1.07$	$0.59 + j0.22$

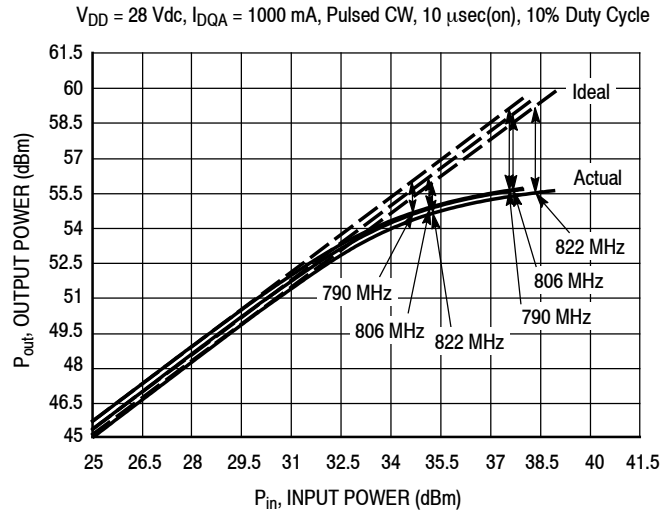
$Z_{source}$  = Test circuit impedance as measured from gate to ground, gate leads are tied together.

$Z_{load}$  = Test circuit impedance as measured from drain to ground, drain leads are tied together.



**Figure 10. Series Equivalent Source and Load Impedance**

## ALTERNATIVE PEAK TUNE LOAD PULL CHARACTERISTICS



NOTE: Load Pull Test Fixture Tuned for Peak P1dB Output Power @ 28 V

f (MHz)	P1dB		P3dB	
	Watts	dBm	Watts	dBm
790	288	54.6	363	55.6
806	299	54.8	366	55.6
822	287	54.6	349	55.4

Test Impedances per Compression Level

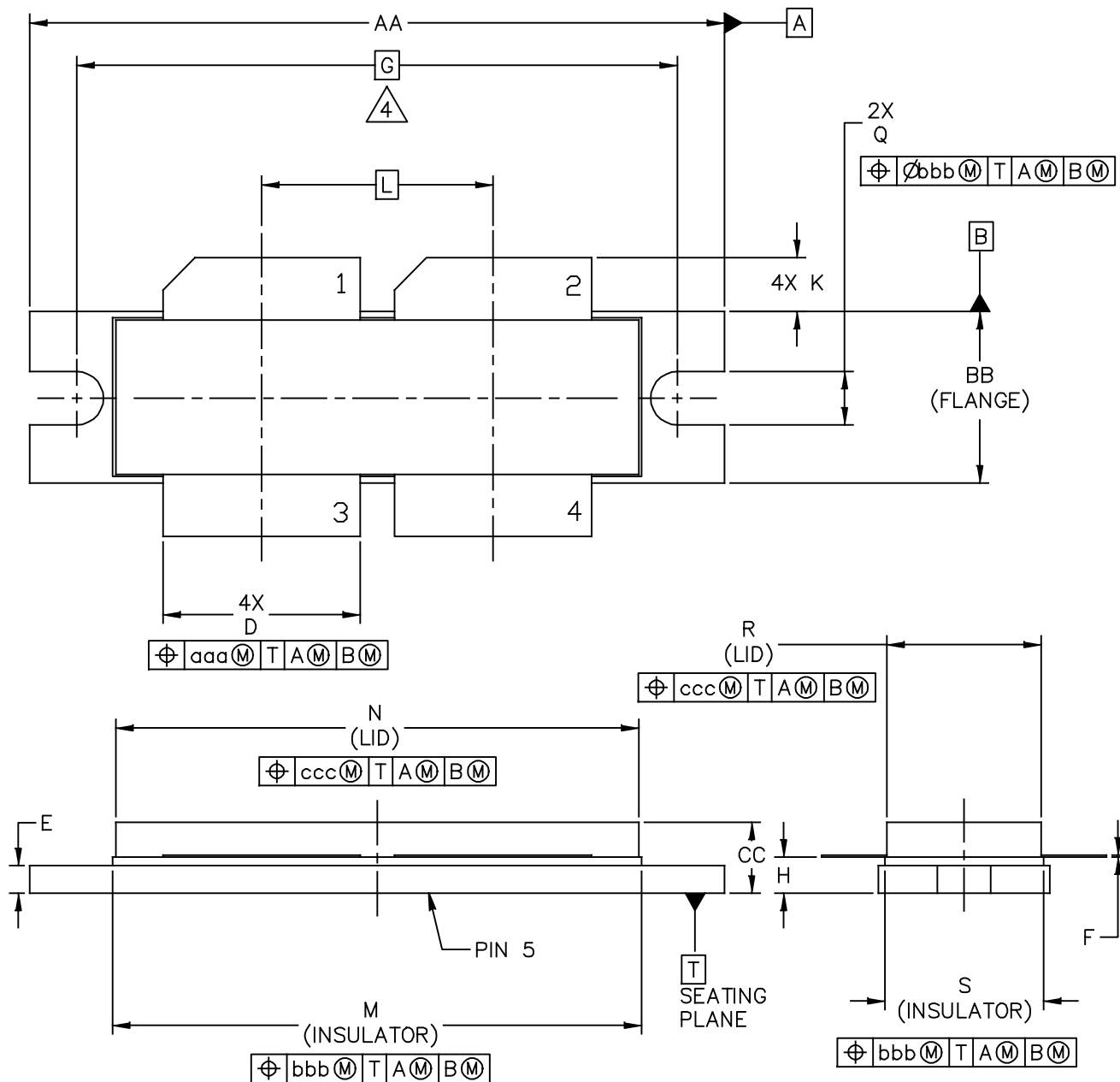
f (MHz)		$Z_{\text{source}}$ $\Omega$	$Z_{\text{load}}$ $\Omega$
790	P1dB	1.04 - j0.98	0.78 - j0.73
806	P1dB	1.16 - j1.39	0.76 - j0.71
822	P1dB	1.24 - j1.73	0.76 - j0.74

**Figure 11. Pulsed CW Output Power versus Input Power @ 28 V**

Note: Measurement made on a per side basis.



PACKAGE DIMENSIONS



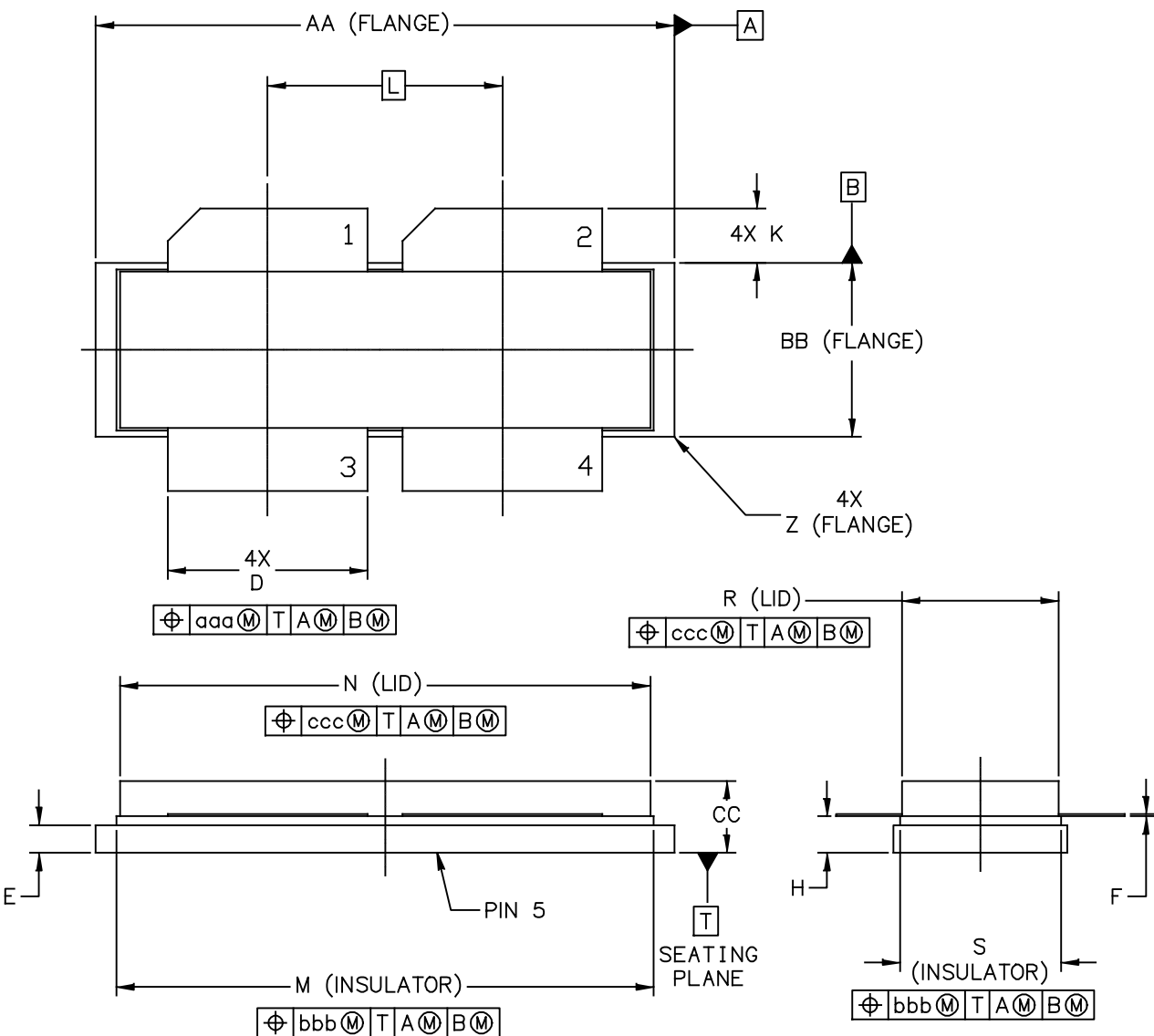
© FREESCALE SEMICONDUCTOR, INC. ALL RIGHTS RESERVED.	MECHANICAL OUTLINE	PRINT VERSION NOT TO SCALE
TITLE:  NI-1230-4H	DOCUMENT NO: 98ASB16977C	REV: F
	STANDARD: NON-JEDEC	
	28 FEB 2013	

NOTES:

1. INTERPRET DIMENSIONS AND TOLERANCES PER ASME Y14.5M-1994.
2. CONTROLLING DIMENSION: INCH
3. DIMENSION H IS MEASURED .030 INCH (0.762 MM) AWAY FROM PACKAGE BODY.

4. RECOMMENDED BOLT CENTER DIMENSION OF 1.52 INCH (38.61 MM) BASED ON M3 SCREW.

DIM	INCH		MILLIMETER		DIM	INCH		MILLIMETER	
	MIN	MAX	MIN	MAX		MIN	MAX	MIN	MAX
AA	1.615	1.625	41.02	41.28	N	1.218	1.242	30.94	31.55
BB	.395	.405	10.03	10.29	Q	.120	.130	3.05	3.30
CC	.170	.190	4.32	4.83	R	.355	.365	9.02	9.27
D	.455	.465	11.56	11.81	S	.365	.375	9.27	9.53
E	.062	.066	1.57	1.68					
F	.004	.007	0.10	0.18					
G	1.400 BSC		35.56 BSC		aaa	.013		0.33	
H	.082	.090	2.08	2.29	bbb	.010		0.25	
K	.117	.137	2.97	3.48	ccc	.020		0.51	
L	.540 BSC		13.72 BSC						
M	1.219	1.241	30.96	31.52					
© FREESCALE SEMICONDUCTOR, INC. ALL RIGHTS RESERVED.			MECHANICAL OUTLINE			PRINT VERSION NOT TO SCALE			
TITLE:  NI-1230-4H					DOCUMENT NO: 98ASB16977C      REV: F				
					STANDARD: NON-JEDEC				
					28 FEB 2013				



© FREESCALE SEMICONDUCTOR, INC. ALL RIGHTS RESERVED.	MECHANICAL OUTLINE	PRINT VERSION NOT TO SCALE
TITLE:  NI-1230-4S	DOCUMENT NO: 98ARB18247C      REV: G	
	STANDARD: NON-JEDEC	
	01 MAR 2013	

NOTES:

1. INTERPRET DIMENSIONS AND TOLERANCES PER ASME Y14.5M–1994.
2. CONTROLLING DIMENSION: INCH
3. DIMENSION H IS MEASURED .030 INCH (0.762 MM) AWAY FROM PACKAGE BODY

DIM	INCHES		MILLIMETERS		DIM	INCHES		MILLIMETERS	
	MIN	MAX	MIN	MAX		MIN	MAX	MIN	MAX
AA	1.265	1.275	32.13	32.39	R	.355	.365	9.02	9.27
BB	.395	.405	10.03	10.29	S	.365	.375	9.27	9.53
CC	.170	.190	4.32	4.83	Z	R.000	R.040	R0.00	R1.02
D	.455	.465	11.56	11.81					
E	.062	.066	1.57	1.68	aaa	.013		0.33	
F	.004	.007	0.10	0.18	bbb	.010		0.25	
H	.082	.090	2.08	2.29	ccc	.020		0.51	
K	.117	.137	2.97	3.48					
L	.540 BSC		13.72 BSC						
M	1.219	1.241	30.96	31.52					
N	1.218	1.242	30.94	31.55					
© FREESCALE SEMICONDUCTOR, INC. ALL RIGHTS RESERVED.			MECHANICAL OUTLINE			PRINT VERSION NOT TO SCALE			
TITLE:  NI-1230-4S					DOCUMENT NO: 98ARB18247C      REV: G				
					STANDARD: NON-JEDEC				
					01 MAR 2013				

## PRODUCT DOCUMENTATION, SOFTWARE AND TOOLS

Refer to the following documents, tools and software to aid your design process.

### Application Notes

- AN1955: Thermal Measurement Methodology of RF Power Amplifiers

### Engineering Bulletins

- EB212: Using Data Sheet Impedances for RF LDMOS Devices

### Software

- Electromigration MTTF Calculator
- RF High Power Model
- .s2p File

For Software and Tools, do a Part Number search at <http://www.freescale.com>, and select the "Part Number" link. Go to the Software & Tools tab on the part's Product Summary page to download the respective tool.

## REVISION HISTORY

The following table summarizes revisions to this document.

Revision	Date	Description
0	Jan. 2011	<ul style="list-style-type: none"> <li>• Initial Release of Data Sheet</li> </ul>
1	Apr. 2013	<ul style="list-style-type: none"> <li>• Changed operating frequency from 790–820 MHz to 750–820 MHz due to expanded device frequency capability resulting from additional test data, p. 1</li> <li>• Table 3, ESD Protection Characteristics, removed the word "Minimum" after the ESD class rating. ESD ratings are characterized during new product development but are not 100% tested during production. ESD ratings provided in the data sheet are intended to be used as a guideline when handling ESD sensitive devices, p. 2</li> <li>• Replaced Case Outline 98ASB16977C, Issue E with Issue F, p. 9, 10. Changed dimension C from 0.150"–0.200" to CC 0.170"–0.190".</li> <li>• Replaced Case Outline 98ARB18247C, Issue F with Issue G, p. 11, 12. Changed dimension C from 0.150"–0.200" to CC 0.170"–0.190". Added minimum Z dimension R0.00".</li> </ul>

### ***How to Reach Us:***

**Home Page:**  
[freescale.com](http://freescale.com)

**Web Support:**  
[freescale.com/support](http://freescale.com/support)

Information in this document is provided solely to enable system and software implementers to use Freescale products. There are no express or implied copyright licenses granted hereunder to design or fabricate any integrated circuits based on the information in this document.

Freescale reserves the right to make changes without further notice to any products herein. Freescale makes no warranty, representation, or guarantee regarding the suitability of its products for any particular purpose, nor does Freescale assume any liability arising out of the application or use of any product or circuit, and specifically disclaims any and all liability, including without limitation consequential or incidental damages. "Typical" parameters that may be provided in Freescale data sheets and/or specifications can and do vary in different applications, and actual performance may vary over time. All operating parameters, including "typicals," must be validated for each customer application by customer's technical experts. Freescale does not convey any license under its patent rights nor the rights of others. Freescale sells products pursuant to standard terms and conditions of sale, which can be found at the following address: [freescale.com/SalesTermsandConditions](http://freescale.com/SalesTermsandConditions).

Freescale and the Freescale logo are trademarks of Freescale Semiconductor, Inc., Reg. U.S. Pat. & Tm. Off. All other product or service names are the property of their respective owners.

© 2011, 2013 Freescale Semiconductor, Inc.